

EN

UNIOR®

Motorbike tools 2017



UNIOR d.d.
Kovaška cesta 10
3214 ZREČE, Slovenia
T: +386 3 757 81 00
F: +386 3 576 26 43
moto@unior.si
www.uniortools.com





Engine



A

Tools for drives



B

Wheel and suspension



C

Axle and bearing



D

Ignition and carburation



E

Accessories for service and garage



F

Maintenance sets



G

Multifunction tools



H

A COMPLETE SOLUTION - A COMPLETE LIFE CIRCLE



FORGING PARTS AND SINTER

By drop forging steel and machining, we make forging parts for control mechanisms and gearboxes, supporting parts of chassis, components for drive shafts and sinter forging parts for the most renowned European and global makers of vehicles: VW, Audi, Renault, Dacia, BMW, ZF Lemförder & ZF Lenksysteme, Jtekt, GKN, Arvin Meritor, BPW, Schäffler KG, Betek and Cimos. Various certificates, tests and awards for excellence confirm the quality of forging parts made in Unior.

SPECIAL MACHINES

Unior mechanical equipment provides comprehensive solutions, ranging from the concept stage to the finished product. Besides specific CNC machine tools for the serial working of aluminium castings or forging parts, Unior also offers flexible production cells, machines for deep hole drilling, for working ends and for working chassis parts, machines with a rotary table and special purpose machines. Unior is a supplier of machines for renowned car manufacturers such as VW, BMW, Audi, Daimler etc.



TOURISM

Unior, which operates in the shelter of the Pohorje mountain range, surrounded by an attractive landscape, is developing two interrelated tourist centres. The Rogla climatic health resort, Olympic centre and winter sports centre is especially interesting for professional athletes and recreational athletes, while the Terme Zreče spa is ideal for those seeking health and wellbeing. Both connected health resorts with their modern capabilities are an excellent choice for family holidays, health rehabilitation and preparation for top athletes.

www.rogla.eu | www.termo-zrece.eu

HAND TOOLS

The development of Unior hand tools constantly follows the requirements of professional and amateur craftsmen all over the world. Top quality materials and original design solutions are the basis of the extreme practicality, effectiveness and long service life of more than 5,500 hand tools. The availability of tools is ensured by a multi branch distribution network. With its cold forged products, Unior is an important supplier of tools for the European industry.

ŠTORE STEEL

Co-owner of the steelworks material: chrome vanadium rods

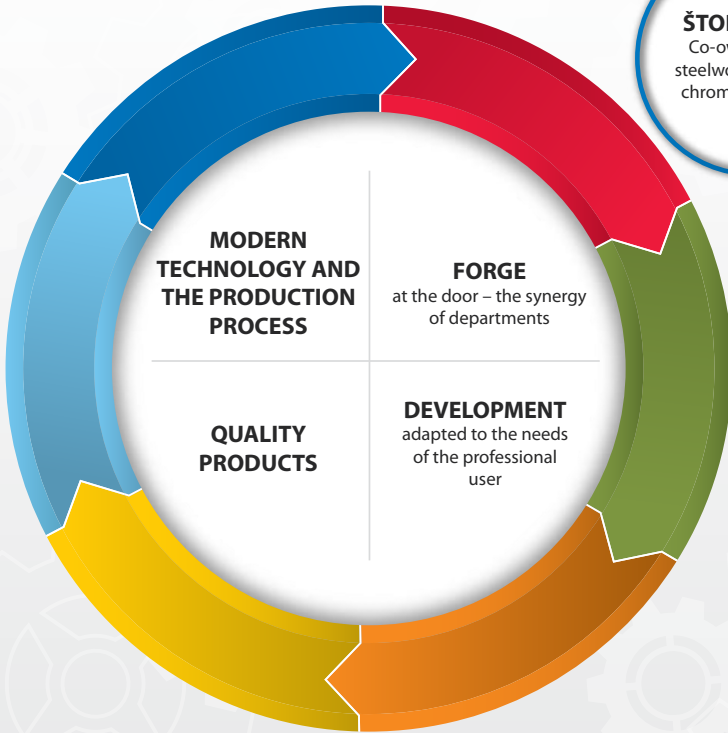

PARTNERSHIP

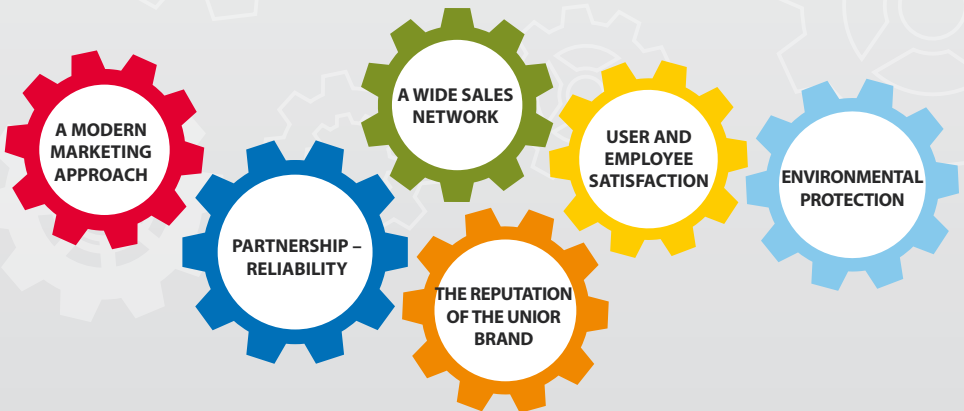

Milestones of the Unior corporation

From Styria to the world

On the outskirts of the Pohorje Mountains, the first ironworks (foundries) were established in the 18th century. They operated as larger forges, in which land and tradesmen's tools were fashioned by hand.

1919

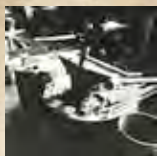

In 1919 the Štajerska železindustrijska družba (Styrian Iron Industry Company) forging plant, with the shortened name Štajerska Zrece, was established. It produced forged hand tools for farming, forestry and various other trades.

1970

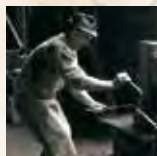

In the 1970s the plant equipped with a new development strategy also obtained a new name: Unior, tovarna kovanega orodja Zrece. The new name was formed from the words "Univerzalno Orodje" (Universal Tools), by which the company had been known for a long time.



In 1950 the plant, burned down during the war and partially renovated in the years following the war and bearing the new name of Tovarna kovanega orodja Zrece (TKO) came under state ownership. New capacities (tool shop and hand tools mechanical processing plant) comprised the basis for developing two production lines: hand tools and drop forgings.

1950

Infinite enthusiasm gives us the strength to reach milestones

Through permanent development while realising the necessity of changes and a competitive advantage we are consistently taking on new challenges with regard to all activities of the company thus ensuring successful operations.

1975

In the mid-1970s Unior began building the Rogla climatic health resort and Olympic centre on Pohorje, and a few years later construction of the Terme Zreče spa commenced and with it, the Tourism Programme.

1997

In 1997 this successful Slovenian company with stable international partnerships was transformed into the UNIOR, d. d. joint stock company. Already at that time, the company had been operating in accordance with ISO 9001 quality standards.



By the 1980s Unior had established its name as an important partner of the European automotive industry, namely as one of the largest European producers of light forgings and as one of the largest European producers of connecting rods for petrol engines. Initial development was enabled by a contract with the Renault concern, on the basis of which a joint-venture plant for the production of forgings was built in Zreče. At the same time, Unior developed its production of homokinetic joints and machine tools, initially intended for the company's own needs.

Unior Joint-Stock Company is today one of the largest and most important Slovenian exporters. With its five production segments company follows the tradition of a high quality and innovation. Committed to high utilization of own capacities, Unior enhances the brand awareness through more than 2400 employees and 32 group companies around the world.

1980

2017

UNIOR IS A PARTNER TO NUMEROUS INTERNATIONALLY RECOGNIZED BICYCLE, AUTOMOBILE AND MOTORCYCLE TEAMS.









 **UNIOR**[®]
Motorbike tools 

#WorldOfUnior





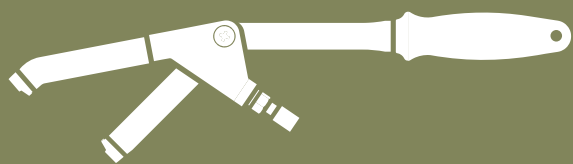

3050/2BI

CLUTCH AND GEAR WHEEL HOLDING TOOLS

- material: special tool steel
- surface finish: chrome plated to standard EN 12540
- ergonomic heavy duty double component handle







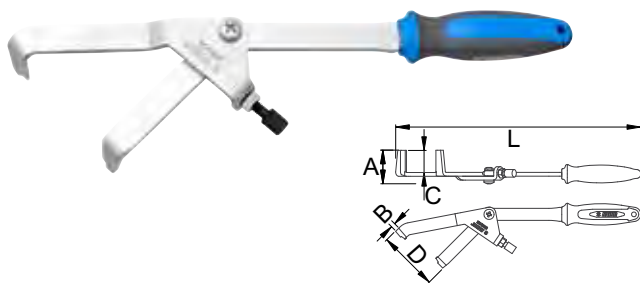

Advantages:

- Its wedge-shaped gripping shanks provide grip between teeth while preventing them from being damaged.
- The tool also includes a screw, which enables the tool to be fixed in a certain position and, consequently, a firm grip.

Usage:

- The tool is designed for holding the clutch, gears and the cam shaft when tightening gears in the range up to 130 mm during assembly and disassembly.
- all types of motorbikes



								
620261	40	130	35	6	53	390	637	1G



3051/2BI

ROTOR AND SPROCKET HOLDING TOOLS

- material: special tool steel
- surface finish: chrome plated to standard EN 12540
- ergonomic heavy duty double component handle

Advantages:

- Due to its universal structure, it allows holding holes with a diameter of 5 or 9 mm and at a distance between 20 to 180 mm.
- The tool also has a screw that enables fixing of the tool at the actual distance between holes on the magnet or the sprocket.

Usage:

- The tool is designed for holding the magnet and the sprocket during assembly or disassembly.
- all types of motorbikes

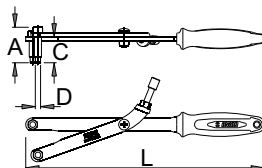

Barcode	D	D1	D2	L	A	Icon 1	Icon 2	IG
620262	20	180	5	9	340	32	604	IG





VALVE SPRING COMPRESSOR FOR MOTORBIKES

- material: special tool steel
- entirely hardened and tempered
- surface finish: chrome plated according to EN12540
- ergonomic heavy duty double component handle
- valve spring compressor not include pressure pieces
- pressure pieces (article 2202.1/2) of dimensions 17, 21, 25 mm allow working on almost all motorbikes and are available as spare parts

Advantages:

- suitable for almost all engines due to its wide range of adjustment
- after adjusting the tool for the first valve, the speed of work increases as readjusting is not necessary for subsequent valves.
- using its very fast and easy with lever blockade
- adjustable handles enable desired pressure on the spring.

Usage:

- This tool is used to attach and detach valve springs and features a self-locking lever and quickly-adjustable fittings to allow it to be used with all kinds of engines.

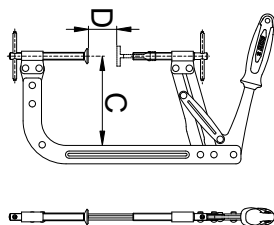



	D±	Df	C		
620263	25	170	140	1520	TG

2202.1/2

PRESSURE PIECES FOR VALVE SPRING COMPRESSOR

- material: special tool steel
- entirely hardened and tempered
- dimensions 17, 21, 25 for motorbikes, 21, 25, 30, 35, 43 for cars



	D		
623218	17	25	1E
620567	21	46	1E
620208	25	54	1E
620209	30	62	1E
620210	35	84	1E
620211	43	106	1E

3055/4A

FLYWHEEL PULLER WITH EXTERNAL THREAD

- material: special tool steel
- surface finish: blacken to standard DIN 50938
- treads M10, M14, M16, M18, M24 are right hand, M27 are left hand



Advantages:

- The tool has 6 different sizes of external thread, thus enabling coverage of the majority of motor types that have a flywheel with an internal thread.
- allows flywheel removal without pulling motor from hull
- On each axis, there is an attachment for an open-end wrench that makes the removal of the magnet easier.

Usage:

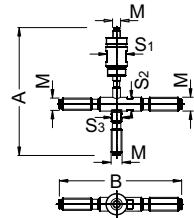
- for removal of the flywheel with internal thread



	M	M	M	M	M	M	S1	S2	S3	A	B		
620278	M10 x 1	M14 x 1,5	M16 x 1,5	M18 x 1,5	M24 x 1	M27 x 1	24	14	11	168	160	531	TE

3055/4B

FLYWHEEL PULLER WITH EXTERNAL THREAD

- material: special tool steel
- surface finish: blacken to standard DIN 50938
- all treads are right hand

Advantages:

- The tool has 4 different sizes of external thread, thus enabling coverage of the majority of motor types that have a flywheel with an internal thread.
- allows flywheel removal without pulling motor from hull
- On each axis, there is an attachment for an open-end wrench that makes the removal of the magnet easier.

Usage:

- for removal of the flywheel with internal thread

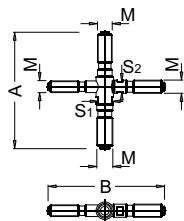

Barcode	M	M	M	M	S1	S2	A	B	Icon 1	Icon 2
620279	M16 x 1,5	M18 x 1,5	M20 x 1,5	M22 x 1,5	19	14	161	161	630	1E

3056/2

SOCKET 1/2" WITH THIN WALL

- material: chrome molybdenum
- surface finish: chrome plated according to EN12540
- intended for use where there is not enough place for working with standard socket wrenches

Important!

- will not withstand torque according to DIN standard for standard socket wrenches

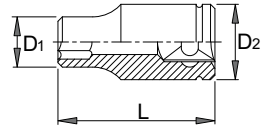

		L	D1	D2		
620280	3/4"	38,5	23,9	23,9	61	4B
620281	5/8"	38,5	21,5	22,5	59	4B
620282	19	38,5	23,9	23,9	60	4B

3059



VALVE SEAL REMOVAL SET FOR MOTORBIKES

- material: special tool steel, polyethilen
- surface finish: chrome plated according to EN12540
- Dimension of box: 321 x 198 x 54

Advantages:

- enables the removal of valve seals without removing the head of the motor
- accessory for assembling pins from Ø5mm to Ø9 mm
- the accessories covers the following dimensions of spark plugs M10x1, M12x1.25, M14x1.25 and M18x1.5
- accessories for removing pins diameter Ø8mm, Ø13 mm and Ø16 mm
- accessories for assembling seals Ø12 and Ø14mm

Usage:

- The individual piston is set into a lower position. In the place of the spark plug, an attachment for the pressure pipe is connected; the cylinder is filled with compressed air, which enables the valves to stay in the upper position.
- Find an appropriate attachment for pulling the pin, set it onto the cover of the spring, straighten the magnets with pins and press the springs by pushing with your hand.
- This enables the pins to be removed from the groove of the valve.
- Remove the cover and the springs.
- Take the valve seal removal pliers art. 2201/2BI, pull out the seals, take the accessories for assembling the seals, place the new seals.
- Place back the springs and the cover; place the pins and use the accessories for assembling the pins to compress the springs by hand, which enables the placement of the pins back onto the valve.
- Repeat the same procedure on all other valves, then remove the accessories for the pressure pipe and repeat the procedure on the next cylinder



623219



IG



3054/4

FLYWHEEL PULLER WITH INTERNAL THREAD

- material: special tool steel, hardened and tempered
- surface finish: blacken to standard DIN 50938

Advantages:

- allows flywheel removal on the motorcycle
- On the puller, there is an attachment for an open-end wrench, which should be hold the magnet

Usage:

- for removal of flywheels with external thread

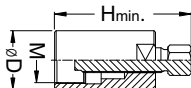

Barcode	Part No.	D	H	Hmin	M	Weight	Material
	620270	M24 x 1.5	32	80	332	TE	
	620271	M26 x 1	34	80	353	TE	
	620272	M28 x 1	36	80	385	TE	
	620273	M30 x 1	38	80	417	TE	
	620274	M30 x 1.5	38	80	432	TE	
	620275	M35 x 1.5	45	90	666	TE	
	620276	M38 x 1.5	48	105	880	TE	
	620277	M50 x 1.5	60	105	1254	TE	

3054.1/4

CRANKSHAFT PROTECTOR CAP

- material: special tool steel, hardened and tempered
- surface finish: blacken to standard DIN 50938
- M12x1,25 (it is part of puller M24x1,5)
- D12mm (it is part of puller M26x1)
- M14x1,25 (it is part of puller M28x1)
- M16x1,5 (it is part of puller M38x1,5)

Advantages:

- enables protection of the drive shaft by pulling flywheel

Usage:

- The protector caps are screwed onto the motor's crankshaft and protect the crankshaft when the magnet is being removed. The protector caps are used when relatively small nuts are used to secure the magnet to the crankshaft. It is especially important to use the protector caps on engines where the lubrication system for lubricating the end bearings runs through the centre of the crankshaft (hollow crankshafts).



Barcode	Part No.	3054/4	Weight	Material
	624225	M12x1.25 M24x1.5, M28x1	45	TE
	624226	D12 M26x1	45	TE
	624227	M14x1.25 M28x1	40	TE
	624228	M16x1.5 M38x1.5, M50x1.5	60	TE



1977/6



OIL-FILTER WRENCH

- material: special tool steel
- lacquered
- for assembling or disassembling oil filters
- for oil filters in restricted access area
- used with ratchet 3/8" and proper extension bar

How to use the tool:

- This tool comes in as many as 12 sizes, which can be used on the majority of standard car and motorbike oil filters on the market. Using it is simple as all that is needed is to place the appropriate tool on the filter and rotate it with ease. The tool can also be used when fitting oil filters as the design and material have been carefully selected so that the tool can withstand the maximum force applied to it. Because of the surface protection, the tool is highly resistant to scratches and damage as well as to atmospheric and chemical effects.

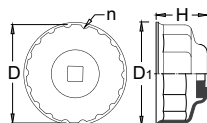

Barcode	D	360°/n	D1	H	Weight	Material
620949	27	6	37.5	33.5	68	1E
620950	32	6	43.5	34.6	81	1E
620951	36	6	48.4	34.9	89	1E
619258	66	6	73	37	124	1E
619259	65	14	70.7	36.8	129	1E
620267	68	14	73.5	36.8	130	1E
620268	73	14	79.3	36.8	152	1E
619260	74	15	81	36	146	1E
619261	75 - 77	15	81.4	41.8	165	1E
620269	76	8	82	36.5	141	1E
619262	76	12	82	35	137	1E
620952	76	14	81.3	37	160	1E
619263	86	16	96	47.2	201	1E
619264	86	18	92	39.5	171	1E
619265	96	18	102	36.8	190	1E







3200/2BI



CHAIN BREAKER. PRESS AND RIVETING TOOL FOR MOTORBIKE

- material: special tool steel
- surface finish: chrome plated to standard EN 12540
- ergonomic heavy duty double component handle
- Dimension of box: 321 x 198 x 54

Usage:

- for DID chains with graduation 520. 525. 530 and 532
- for Regina chains with graduation 520. 525. 530
- for RK chains with graduation 520. 525. 530 and 532
- compatible with most motorcycle drive chains

Disassembling the chain:

- a robust set for disassembling a chain without any prior grinding of the pin
- select the appropriate pin (diameter Ø3, Ø4 or Ø5 mm) and bushing (Ø4, Ø5 or Ø6 mm) corresponding to the pin diameter on the chain
- insert the pin into the tool, then position the tool on the chain link and rotate the tool until the chain pin falls out

Assembling the chain:

- assemble the chain according to the manufacturer's instructions
- select an appropriate set of pressing adapters depending on the size of the plates (guide widths to 13.5 mm or 16 mm)
- position the set into the tool. Place the tool on the connecting chain link and press the link by rotating the riveting tool using the handle until the plates and the chain are tightly connected
- after the chain link and the plates have been successfully aligned, install the chain pin
- You can choose from 3 types of riveting pins (type A, B or C)
- place the riveting set into the tool and rotate the handle to cause a deformation of the head of the pin, so the diameter is between 5.5 to 5.8 mm as recommend the chain manufacturer's instructions

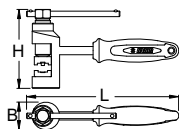

623220

B

40

H

115

L

270

2490

1G

3057/2

VARIATOR AND CLUTCH DRIVE HOLDER TOOL WITH RING WRENCH

- material: special tool steel
- surface finish: chrome plated to standard EN 12540

Advantages:

- comes with 3 different lengths of accessories that cover several types of drives

Usage:

- for scooters PIAGGIO. GILERA 50-125cm; water- and air-cooled
- has a triple function
- it is used as a block for the gear on the starter when untightening the front part of the drive
- accessories for holding the pot on the back part of the drive for untightening the nut
- wrench for untightening the inside nut of the back part of the drive

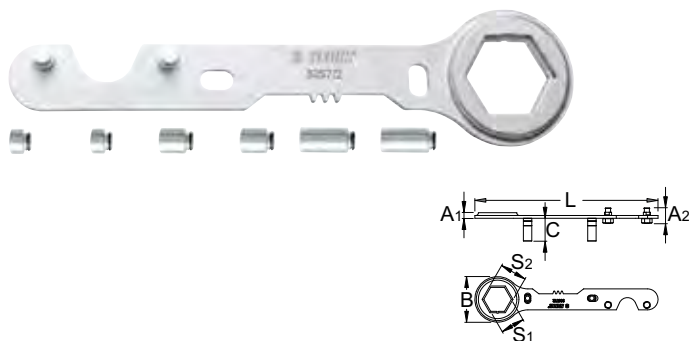

623187	A1	A2	B	C	S1	S2	L		
	8	22	65	32.5	34	38	262	319	TE

3057.1/2

UNIVERSAL VARIATOR HOLDER TOOL

- material: special tool steel
- surface finish: chrome plated to standard EN 12540
-

Advantages:

- comes with 3 different lengths of accessories that cover several types of drives

Usage:

- it is used as a block for the gear on the starter when untightening the front part of the drive
- for scooters PIAGGIO. GILERA 50-125ccm; water- and air-cooled

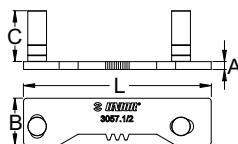

Barcode	A	B	C	L	Weight	Material
623188	5	30	32.5	120	150	1E

3201/2



TOOL FOR CONTROLLING CAM BELT TENSION FOR MOTORCYCLE

- material: special tool steel
- surface finish: chrome plated according to EN12540

Usage:

- it is used for the control of the tension of the drive belts
- Controlling tool is mounted onto the belt. On the marked part of the engine the belt is forced by hand to establish the sag of the belt so that it is in conformance with the pressure force of 45N and with the sag prescribed by motorbike producer.
- used in accordance with the servicing instructions
- ergonomic handle

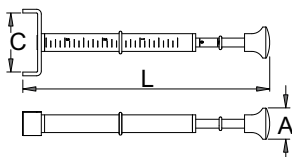

	A	C	L		
620286	21	40.5	164	100	1G





3301/2

SPOKE WRENCH FOR MOTORCYCLE

- material: special tool steel
- surface finish: chrome plated according to EN12540

Advantages:

- the ergonomic shape of the wrench enables simple access and great strength when tightening and unscrewing

Usage:

- the spoke wrench is used for tightening spoke nipples

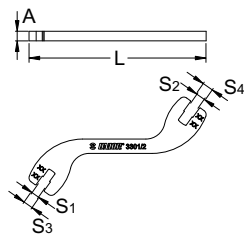

Barcode	S1	S2	S3	S4	L	A	Weight	Material
620296	5	6	6,3	7	111	6	71	4A
623186	5,4	5,6	6,5	6,8	111	6	71	4A



3302/6

STAND FOR MOTORCYCLE WHEEL ALIGNMENT

- material: special tool steel
- lacquered housing, other parts zinc plated
- the stand is intended mainly for use in motorbike repair services and for home users

Advantages:

- the stand has a spirit level for setting in a horizontal position
- it enables radial control of the rim position with a sensor
- The geometry of the calipers enables a simultaneous axial control for accurate truing of the rim.
- The stand enables fixing of cones to the axis that enable the centering of the wheel on its own bearings, thus preventing the possibility of centering errors.
- it has two positions for setting columns regarding the width of the hub
- the rotation of the axis on external bearings enables centering on the standard method

Usage:

- Wheels with dimensions to max 32 inches can be centered.
- for axis dimensions of 12 to 36 mm

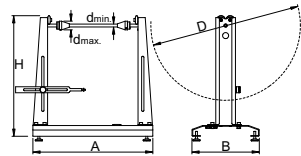

	Df	d min	d max	A	B	H		
620297	32"	12	36	500	280	525	9600	1G



3303/2

DISC SPREADER FOR MOTORCYCLE

- material: special tool steel
- surface finish: chrome plated to standard EN 12540

Important!

- For compressing double or triple brake pistons, we leave the used brake pads in the brake housing. This will prevent one of the pistons being pushed from the housing.
- after compressing replace the worn out brake pads with the new one

Usage:

- The tool is used for compressing brake pistons when replacing brake pads. The tool is useful for compressing single, double and tripple brake pistons The tool enables quick and easy pressing of brake pistons back into the housing without additional damage to the piston or the housing.

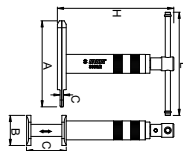

Barcode	L	A	B	C↓	C↑	Weight	Material
620298	120	100	35	4	45	507	1G



3305/2

HOLDING TOOL FOR CARTRIDGE ROD OF SHOCK ASORBERS FOR MOTORBIKES

- material: special tool steel
- surface finish: chrome plated according to EN12540

Usage:

- Tool is used when replacing bushings, seals and oil of front shock absorbers.
- The tool is inserted between the housing and the nut and keeps us at the top of the shock absorber by assembling and disassembling.

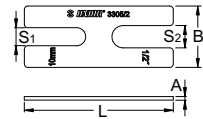

Barcode	A	B	L	S1	S2	Weight	Material
623246	2	35	85	10,3	12,7	34	1E



2034/2BI



TOOL FOR SET TYRES VALVELETS

- material: chrome vanadium
- ergonomic heavy duty double component handle
- jet stamp UNIOR
- for setting tyre Schrader valvelets
- the handle features plastic-coated grooves that prevent sliding and thus any damage to wheel rims. The tool is appropriate for all dimensions of wheel rims.

How to use the tool:

1. Insert the new valvelet into the opening on the wheel rim.
2. Screw the tool on the valvelet.
3. Use the lever to pull the valvelet in the proper position on the wheel rim.

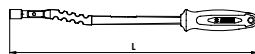
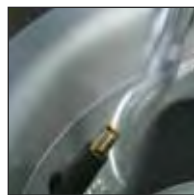

	L		
619738	325	273	4B



2042/2

TOOL FOR TYRES VALVELETS

- material: special tool steel
- surface finish: chrome plated according to EN12540
- for assembling and disassembling Schrader valvets mechanism
- one end is designed for assembling and disassembling of mechanism, other end for releasing the air

Advantages:

- the handle of the tools are serated for a better grip

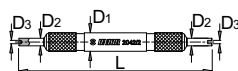

Barcode	L	D1	D2	D3	Weight	Material
621998	115	11	4,5	2	65	4A

300/5

TYRE LEVER

- material: chrome vanadium
- forged
- hardened and tempered
- surface finish: zinc plated
- drop forged, entirely hardened and tempered

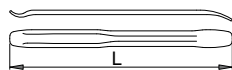

Barcode	L	Weight	Material
617661	200	111	1C
601755	300	253	1C
601756	400	452	1C
601757	500	648	1C



300/5C

TYRE LEVER WITH HANDLE

- material: special tool steel
- surface finish: chrome plated according to EN12540
- ergonomic heavy duty double component handle

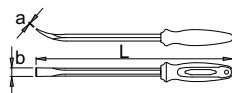

Barcode	L	a x b	Weight	Code
613103	320	1.1 x 13	252	4B
613104	410	1.5 x 15	499	4B
613105	610	1.5 x 21	837	1C

300CCB

SET OF TYRE LEVERS WITH HANDLE



Barcode	Quantity	Weight	Code
613106	3	878	1F
300/5C (320, 410, 610)			



2051/4



SUSPENSION COMPRESSOR FOR SHOCK ABSORBER SPRINGS

- This Unior professional tool, under article number 2051, is intended for the removal of car shock absorbers and is mainly used to compress the springs in MacPherson struts. Since the number of versions of the MacPherson strut is always increasing, the tool set contains three different pairs of grippers that almost completely cover the range of different MacPherson struts. The tool set also includes a spacer bar for conical springs, which increases the usefulness of the Shock Absorber Remover. Development of this tool took safety into account as the large forces involved in removing shock absorbers may present a risk of injury to the user. For this reason, all grippers in the set feature enlarged grip edges to firmly grip the spring in the tool thus prevent any possibility of slipping, which could injure the tool user. The recommended load for the tool is 9000 N. The maximum load for the tool is up to 37000 N. The tool is supplied in a durable PVC case that enables easier and safer transportation.
- in set 2 cups 80 - 115, 2 cups 110 - 150 in 2 cups 140 - 195

How to use the tool:

1. Select the appropriate cup for your spring.
2. Place the remover on the spring.
3. START compressing the shock absorber spring.

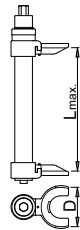
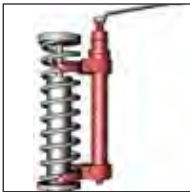

619279	300	21	80 - 195	14600	1G





7172



3401/2P

FLEXIBLE HOOK WRENCH FOR MOTORBIKES

- material: special tool steel
- surface finish: chrome plated according to EN12540
- plastic dipped handle

Advantages:

- the slim version of the wrench enables the setting of slim toothed nuts

Usage:

- for operate setting the telescopes of motorbikes and scooters
- from diameter 32 till 60 mm

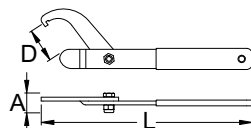

Barcode	A	D↓	D↑	L	Weight	Part No.
620413	20	32	60	220	186	4B

689.1/4

ARM FOR 689/2BI

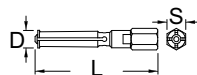

Barcode	D	L	S	Weight	Part No.
623089	6,5 - 8	81	14	45	1E
623090	10 - 12	83	14	51	1E
623091	12 - 15	92	14	67	1E
623092	17 - 20	102,5	14	136	1E
623093	22 - 28	125	17	276	1E
623094	30 - 36	140	22	500	1E

689/2BI

INNER BEARING PULLER

- material: special tool steel
- drop forged, entirely hardened and tempered
- surface finish: chrome plated according to EN12540
- ergonomic heavy duty double component handle

Advantages:

- Set includes 6 pcs of arm for inner bearing dimensions 6.5-8,10-12, 12-15, 17-20, 22-28, 30-36

Usage:

- It is used for pulling different types of bearings. The bearing is gripped from the inside side and pulled out.
- the bearing is extract with a 1 kg weight

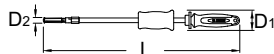
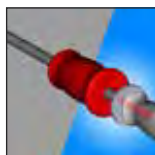

Barcode	D1	D2↓	D2↑	L↓	L↑	Weight	Material
622587	52	6,5	36	495	555	3300	1G



SEPARATOR PULLER

- The separator is made of high quality steel.
- Surface finish of screws: burnished, other parts are chrome-plated
- The separator puller is a tool designed to efficiently dismount various machine parts attached to shafts.
- It is indispensable for tasks requiring the safe and deformation-free dismounting of firmly fixed machine parts.
- Our product range includes three sizes of pullers used for taking off objects from shafts. They range from Ø5 mm to Ø115 mm.

Advantages:

- The separator puller consists of a yoke, a spindle, two arms and a gripper assembly, which together allow uniform dismounting.
- The separator puller is designed to allow easy and safe operation

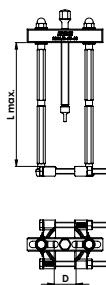

	D	L \bar{f}		
619273	5 - 60	229	2160	1G
619274	12 - 75	234	2930	1G
619275	22 - 115	325	7180	1G

2038



INNER BEARING RACE PULLER

- It is used to easily, quickly and cleanly remove inner bearings from the wheel hub. The tool is designed to remove the inner bearing race without the risk of any damage and without needing any additional tools such as files, hammers or cutters. The tool has 4 track bushes that are used to remove bearing races with diameters from $\varnothing 40$ to $\varnothing 60$ mm. The track bush clasps the bearing race firmly and thus prevents any kind of slippage. The tool can be used for: Audi, BMW, Ford, Mercedes-Benz, Peugeot, Renault, Toyota, VW, etc.
- with 4 jaws; dimension 1 - from $\varnothing 40$ to $\varnothing 45$, dimension 2 - from $\varnothing 45$ to $\varnothing 50$, dimension 3 - from $\varnothing 50$ to $\varnothing 55$, dimension 4 - from $\varnothing 55$ to $\varnothing 60$



620228



3585



1G







3058/2

SPARK PLUG SOCKET 3/8" WITH THIN WALL

- material: chrome vanadium
- surface finish: chrome plated according to EN12540
- drop forged, entirely hardened and tempered
- intended for use where there is not enough space for working with standard wrenches for replacing spark plugs
- inside the socket inserted rubber ring for holding spark plug

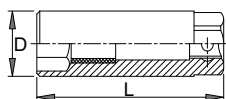

Barcode	⌀	D	L	Hex	h	Wrench
623215	16	20,9	65	19	80	4B
623216	18	22,3	65	22	92	4B
623217	21	25,6	65	19	111	4B

186.4/2A

SPARK PLUG SOCKET 3/8"

- material: chrome molybdenum
- drop forged, entirely hardened and tempered
- surface finish: chrome plated according to EN12540



Barcode	⌀	D	L	Hex	h	Wrench
622513	14	18	63	17	58	4B





2151/2BI

SPARK PLUG PLIERS

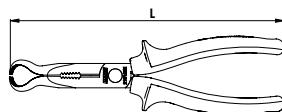
- material: special tool steel
- for removing spark plugs
- heavy duty double - component handles
- jet stamp UNIOR
- This tool is intended for the safe and quick removal of spark plug covers without damaging them. As an added feature, the tool allows you to cut power supply cables or compress cable attachments.



	L		
619732	192	206	4B

CAR LIGHT TESTER 6 - 12/24 V

- Use only on proven automobile installations for voltages of up to 12V and up to 24V
- Use for other purposes or at different voltages may be life threatening.
- The product may not be used for verifying the grid voltage!

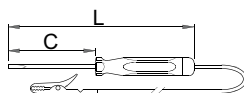

Barcode	V	a x b	C	L	Icon 1	Icon 2
601688	6 - 12	0.5 x 3.0	60	140	25	1E
601689	6 - 24	0.6 x 3.5	90	180	25	1E

631B



CAR LIGHT TESTER 6 - 12/24 V

- Indispensable tool in every car workshop
- Safety cover for the tip of the tester, intended to prevent injuries to users
- Used for checking electrical installations in all 6 - 24 V systems in the car

Usage:

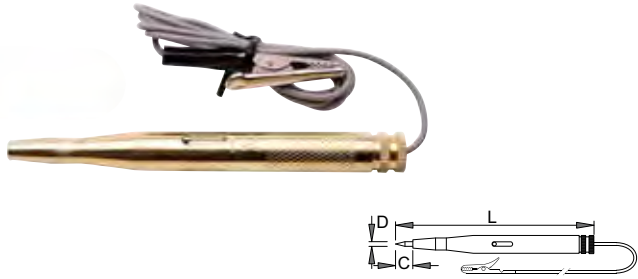
- Connect the clip to any ground point.
- Pierce the wire insulation with the tip of the tester to find live wires
- Keep piercing the insulation along the wire until the tester stops being illuminated, which indicates that the wire is broken.
- Use for other purposes or at different voltages may be life threatening.
- The product may not be used for verifying the grid voltage!



	V	C	D	L		
619856	6 - 24	12	1.8	110	38	1E



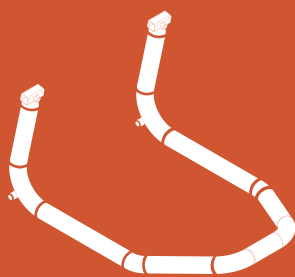

3000/6

FRONT STANT FOR MOTORCYCLE

- Material: constructional steel
- ecologically lacquered with cadmium and lead free colour
- adaptors are chrome plated according to EN12540

Advantages:

- adjustable to the width of the front fork of the motorcycle from 180 to 250 mm
- strong construction enables load capacity up to 200 kg
- quick-change adaptors and setting stands
- reliable and safe lifting of motorcycle

Use:

- The stand is used for servicing and garaging motorcycles
- It is suitable for almost all type of motorbikes



620259



5800



1V

3001/6A

REAR STAND FOR MOTORCYCLE WITH UNIVERSAL ADAPTOR

- material: constructional steel
- ecological lacquered with cadmium and lead free colour
- adaptors are chrome plated according to EN12540

Advantages:

- adjustable to the width of the rear fork of the motorcycle from 270 to 360 mm
- adaptors are PVC coated
- strong construction enables load capacity up to 200 kg
- quick-change adaptors and setting stands
- reliable and safe lifting of motorcycle

Usage:

- the stand is used for servicing and garaging motorcycles
- it is suitable for almost all type of motorbikes



		
620260	5200	1V

3001/6B

REAR STAND FOR MOTORCYCLE WITH V ADAPTOR

- material: constructional steel
- ecological lacquered with cadmium and lead free colour
- adaptors are chrome plated according to EN12540

Advantages:

- adjustable to the width of the rear fork of the motorcycle from 270 to 360 mm
- strong construction enables load capacity up to 200 kg
- quick-change adaptors and setting stands
- reliable and safe lifting of motorcycle

Usage:

- the stand is used for servicing and garaging motorcycles
- it is suitable for almost all type of motorbikes



		
624300	4700	1V

3000.1

ADAPTOR FOR FRONT STAND

- material: constructional steel
- surface finish: chrome plated according to EN12540

Advantages:

- quick-change adaptors and setting stands
- reliable mounting into the groove of the motorcycle front fork

Usage:

- for mounting into the groove of the motorcycle front fork
- it is suitable for almost all type of motorbikes
- use together with base 3001.3



		
624325	1400	1V

3001.1

UNIVERSAL ADAPTOR FOR REAR STAND

- material: constructional steel
- surface finish: chrome plated according to EN12540

Advantages:

- adaptors are PVC coated
- quick-change adaptors and setting stands
- reliable mounting into the groove of the motorcycle front fork

Usage:

- mounting on the rear swinging arm of the motorcycle
- it is suitable for almost all type of motorbikes
- use together with base 3001.3



		
624326	893	1V

3001.2

V ADAPTOR FOR REAR STAND

- material: constructional steel
- surface finish: chrome plated according to EN12540

Advantages:

- quick-change adaptors and setting stands
- reliable mounting into the groove of the motorcycle front fork

Usage:

- reliable mounting on side pin of the rear swinging arm of the motorcycle
- it is suitable for almost all type of motorbikes
- use together with base 3001.3



		
624327	440	TV

3001.3

BASE FOR STAND 3000/6 AND 3001/6

- material: constructional steel
- ecological lacquered with cadmium and lead free colour

Advantages:

- strong construction enables load capacity up to 200 kg
- quick-change adaptors and setting stands
- it's suitable for use with various adaptors

Usage:

- Use together with adapters 3000.1, 3001.1 and 3001.2



		
624328	4200	TV



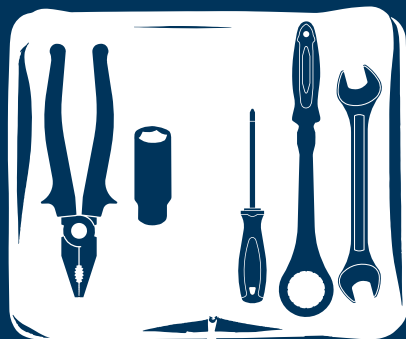

3700

SCOOTER TOOL SET

By using the tool set, you can disassemble:

- the entire shield (plastic parts)
- most parts of the frame
- engine parts like:
 1. replacing spark plugs
 2. changing oil in the transmissions (of the gearbox)
 3. disassembling various engine bonnets
 4. disassembling brakes and replacing brake pads



621893



47



2000



1G

188/2 6p (4, 4.5, 5, 5.5, 6, 7, 8, 9, 10, 11, 12, 13, 14), **187/2HX** (3, 4, 5, 6, 7), **187/2PH** (PH 1, PH 2, PH 3), **187/2TX** (TX 8, TX 10, TX 15, TX 25, TX 27, TX 30, TX 40), **187/2SL** (0.8 x 4, 1 x 5.5, 1.2 x 7), **238.1/1ABI** (3/8"), **188.3/2** (1/4"), **188.4/2** (1/4" x 150, 1/4" x 55), **188.6/2** (1/4"), **238.7/1** (3/8" - 1/4"), **188.8** (1/4"), **238/1 6p** (15, 16, 17, 18, 19), **186.4/2** (21), **236/2HX** (8, 10), **110/1** (13 x 17), **981PBS2** (307 x 260 x 55)

3700PRO

SCOOTER TOOL SET

By using the tool set, you can disassemble:

- the entire shield (plastic parts)
- most parts of the frame
- engine parts like:
 1. replacing spark plugs
 2. changing oil in the transmissions (of the gearbox)
 3. disassembling various engine bonnets
 4. disassembling brakes and replacing brake pads
 5. changing brake fluid
 6. disassembling wheels
 7. for various suspensions and holders



Barcode	Hand icon	Weight icon	Flag icon
621906	56	3200	1G
<p> 188.2 6p (4, 4.5, 5, 5.5, 6, 7, 8, 9, 10, 11, 12, 13, 14), 187/2HX (3, 4, 5, 6, 7), 187/2PH (PH 1, PH 2, PH 3), 187/2TX (TX 8, TX 10, TX 15, TX 25, TX 27, TX 30, TX 40), 187/2SL (0.8 x 4, 1 x 5.5, 1.2 x 7), 188.1/1ABI (1/4"), 188.3/2 (1/4"), 188.4/2 (1/4" x 150, 1/4" x 55), 238.4/2 (3/8" x 75), 188.6/2 (1/4"), 188.8 (1/4"), 238/1 6p (15, 16, 17, 18, 19, 20, 21, 22), 190/1 6p (24), 186.4/2 (21), 236/2HX (8, 10), 238.1/1ABI (3/8"), 238.6/1 (3/8"), 238.7/2 (3/8" - 1/2"), 120/1 (8, 10, 13), 981PB4 (393 x 331 x 95) </p>			

964MOTO1

SET OF MOTORBIKE TOOLS IN SOS TOOL TRAY



624979	6	3500	1F
2202.1/2 (17, 21, 25), 3050/2BI (40x130), 3051/2BI, 3052/2BI, VL964MOTO1 (564x364x30)			

964MOTO2

SET OF MOTORBIKE TOOLS IN SOS TOOL TRAY



624980	14	6800	1F
3054/4 (M24x1,5, M26x1, M28x1, M30x1, M30x1,5, M35x1,5, M38x1,5, M50x1,5), 3050/2BI (40x130), 3054.1/4, 3055/4A, 3055/4B (M16x1,5xM18x1,5xM20x1,5xM22x1,5), VL964MOTO2 (564x364x30)			

964MOTO3

SET OF MOTORBIKE TOOLS IN SOS TOOL TRAY

Advantages:

- enables the removal of valve seals without removing the head of the motor
- accessory for assembling pins from fi 5mm to fi 9 mm
- the accessories covers the following dimensions of spark plugs M10x1, M12x1.25, M14x1.25 and M18x1.5
- accessories for removing pins diameter fi 8mm, fi 13 mm and fi 16 mm
- accessories for assembling seals fi 12 and fi 14mm

Usage:

- The individual piston is set into a lower position. In the place of the spark plug, an attachment for the pressure pipe is connected; the cylinder is filled with compressed air, which enables the valves to stay in the upper position.
- Find an appropriate attachment for pulling the pin, set it onto the cover of the spring, straighten the magnets with pins and press the springs by pushing with your hand.
- This enables the pins to be removed from the groove of the valve.
- Remove the cover and the springs.
- Take the valve seal removal pliers art. 2201/2BI, pull out the seals, take the accessories for assembling the seals, place the new seals.
- Place back the springs and the cover; place the pins and use the accessories for assembling the pins to compress the springs by hand, which enables the placement of the pins back onto the valve.
- Repeat the same procedure on all other valves, then remove the accessories for the pressure pipe and repeat the procedure on the next cylinder



			
624981	1	1000	1F
3059, VL964MOTO3 (188x364x30)			

964MOTO4

SET OF MOTORBIKE TOOLS IN SOS TOOL TRAY

- material: special tool steel

Usage:

- for DID chains with graduation 520, 525, 530 and 532
- for Regina chains with graduation 520, 525, 530
- for RK chains with graduation 520, 525, 530 and 532
- compatible with most motorcycle drive chains





Disassembling the chain:

- a robust set for disassembling a chain without any prior grinding of the pin
- select the appropriate pin (diameter $\varnothing 3$, $\varnothing 4$ or $\varnothing 5$ mm) and bushing ($\varnothing 4$ $\varnothing 5$ or $\varnothing 6$ mm) corresponding to the pin diameter on the chain
- insert the pin into the tool, then position the tool on the chain link and rotate the tool until the chain pin falls out

Assembling the chain:

- assemble the chain according to the manufacturer's instructions
- select an appropriate set of pressing adapters depending on the size of the plates (guide widths to 13.5 mm or 16 mm)
- position the set into the tool. Place the tool on the connecting chain link and press the link by rotating the riveting tool using the handle until the plates and the chain are tightly connected
- after the chain link and the plates have been successfully aligned, install the chain pin
- You can choose from 3 types of riveting pins (type A, B or C)
- place the riveting set into the tool and rotate the handle to cause a deformation of the head of the pin, so the diameter is between 5.5 to 5.8 mm as recommend the chain manufacturer's instructions







			
624982	1	1040	TF
3200/2BI, VL964MOTO4 (188x364x30)			

964MOTO5

SET OF MOTORBIKE TOOLS IN SOS TOOL TRAY







			
624983	5	1000	1F
 192/2HX (17, 19, 22, 24), 3600/2BI (4,2)			

964MOTO6

SET OF MOTORBIKE TOOLS IN SOS TOOL TRAY





			
624984	13	1500	1F
186.4/2A (14), 1977/6 (65x14, 68x14, 73x14, 76x8, 76x12, 76x14), 3056/2 (3/4", 5/8", 19), 3058/2 (16, 18, 21), VL964MOTO6 (188x364x30)			

964MOTO7

SET OF MOTORBIKE TOOLS IN SOS TOOL TRAY







			
624985	3	700	1F
3057/2, 3057.1/2, 3201/2, VL964MOTO7 (188x364x30)			

964MOTO8

SET OF MOTORBIKE TOOLS IN SOS TOOL TRAY



			
624986	5	1076	1F
3301/2 (5x6x6,3x7, 5,4x5,6x6,5x6,8), 3305/2, 3303/2, 3401/2P, VL964MOTO8 (188x364x30)			



2011.11





3600/2BI

SPRING HOOK

- material: blade: special tool steel
- ergonomic heavy duty double component handle

Usage:

- Tool is used for assembling and disassembling springs (spring for support legs, seat and reservoir, by exhaust systems, as assistance in assembling the chain of the cam shaft, etc)
- all types of motorbikes

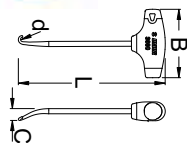

	d	C	B	L		
620411	4,2	130	80	170	67	4B

192/2HX



HEXAGONAL SCREWDRIVER SOCKET 1/2"

- material: socket: chrome vanadium, chrome plated
- material: bit: special tool steel, anticorrosive oiled
- entirely hardened and tempered
- dimensions 17, 19, 22, 24 are used for the removal and fitting of front wheels
- made according to standard DIN 7422 (only metric dimension)

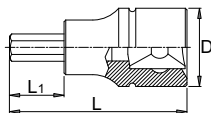

Barcode	Hexagon	D	L	L1	Weight	Material
600978	4	23	60	24	60	4B
603420	5	23	60	24	60	4B
603421	6	23	60	24	60	4B
603422	7	23	60	24	75	4B
603423	8	23	60	24	81	4B
605923	9	23	60	24	85	4B
603424	10	23	60	24	95	4B
603425	12	23	60	24	116	4B
603426	14	23	60	24	168	4B
603427	17	24	60	20	187	4B
603428	19	26.5	60	20	195	4B
623141	22	26.5	60	20	196	4B
623142	24	26.5	60	20	210	4B
619894	3/16"	22.9	40	24	60	4B
619895	7/32"	22.9	40	24	60	4B
619896	1/4"	22.9	40	24	60	4B
619898	5/16"	22.9	40	24	81	4B
619899	3/8"	22.9	40	24	95	4B
619900	1/2"	22.9	40	24	116	4B
619901	9/16"	22.9	40	24	168	4B
619902	5/8"	22.9	40	24	187	4B
619904	3/4"	26.8	40	21	195	4B

2076/1



ROLLER-TYPE STUD EXTRACTOR

- material: chrome vanadium
- surface finish: chrome plated according to EN12540
- polished

Advantages:

- roller system grips on to stud, in both directions
- easy extraction of studs









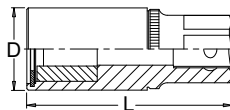









How to use the tool:

1. Position roller-type stud extractor on stud
2. START turning stud extractor COUNTER CLOCK wise
3. When stud removed, simply pull down stud extractor

Important!

- Do not use roller-type stud extractor for tightening!
- Studs are screws without a surface that can be gripped, which prevents their removal without damaging them. This tool is intended to do exactly that – removing studs without damaging the threads. The tool works through a system of three rollers that grip the stud at three points during removal, removing the stud without damaging it. The three rollers have no sharp edges, enabling removal without causing damage as they. Despite this, the tool can work in both directions. Tightening with the tool is not recommended though as the increased force in tightening could damage the system of rollers, which are dimensioned solely for loosening.



		L	D					
619238	M 5	60	21.5	19	3/8"	-	133	
619239	M 6	60	23.5	21	1/2"	-	134	
619240	M 7	60	23.5	21	1/2"	-	131	
619241	M 8	60	23.5	21	1/2"	-	128	
619242	M 10	69	27.5	21	1/2"	-	186	
619243	M 12	69	27.5	21	1/2"	-	190	
619244	M 14	72	34.3	21	-	16	271	
619245	R 1/4"	60	23.5	21	1/2"	-	133	
619246	R 5/16"	60	23.5	21	1/2"	-	129	
619247	R 3/8"	69	27.5	21	1/2"	-	188	
619248	R 7/16"	69	27.5	21	1/2"	-	187	
619249	R 1/2"	72	34.3	21	-	16	275	

2077/2BI



SPRING CLIP PLIERS

- material: special tool steel
- material pivoting tip: special carbon tool steel
- surface finish: chrome plated to standard EN12540
- tips black finish
- heavy duty double - component handles
- jet stamp UNIOR
- for hose clips on cooling, heating, fuel or screen-washer systems

Advantages:

- fits most standard sized clamps
- position lock makes it easy to replace hose clamps



How to use the tool:

- Pliers for are used for opening the tube clamps, enabling quick and safe removal of tubes from tube prolongations. They are also used for closing the tube clamps when tubes are attached to tube prolongations to prevent tubes from falling off the prolongations and thus ensuring safe movement of fluids. The pliers have been designed in such a way so that only a minimum force is sufficient to create large pressure upon the clamp, ensuring safe and durable connection of the tube to the tube prolongation. The pliers have been shaped in such a way so that they can be efficiently used at places which are difficult to access, thus enabling quick and easy handling. Firm and safe grip is ensured by the ergonomic shape of the handles.

Use for:

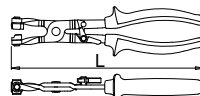
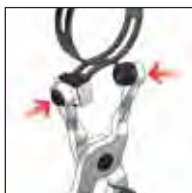
- Alfa Romeo, Audi, Citroen, Fiat, Ford, Hyundai, Lancia, MAN, Mercedes, Opel/Vauxhall, Peugeot, Porsche, Renault, Seat, Toyota, VW, Volvo, etc.



	L		
619250	235	301	4B

2078/2BI



SLOTHOLDER PLIERS FOR OETIKER® COLLARS

- material: special tool steel
- heavy duty double - component handles
- jet stamp UNIOR
- for automotive pressed axlecuffs OETIKER®

Advantages:

- exact deformation of the axlecuff ear
- longer, for easy deformation of axlecuff ears
- for almost all passenger cars

How to use the tool:

- Pliers for are used for opening the tube clamps, enabling quick and safe removal of tubes from tube prolongations. They are also used for closing the tube clamps when tubes are attached to tube prolongations to prevent tubes from falling off the prolongations and thus ensuring safe movement of fluids. The pliers have been designed in such a way so that only a minimum force is sufficient to create large pressure upon the clamp, ensuring safe and durable connection of the tube to the tube prolongation. The pliers have been shaped in such a way so that they can be efficiently used at places which are difficult to access, thus enabling quick and easy handling. Firm and safe grip is ensured by the ergonomic shape of the handles.

Use for:

- Audi, BMW, Chrysler, Ford, GM, Honda, Mazda, Mercedes, Nissan, Opel/Vauxhall, VW

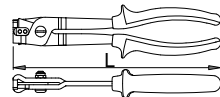

	L		
619251	230	316	4B

2079/2BI



QUICK COUPLER PLIERS FOR FUEL PIPES

- material: special tool steel
- surface finish: chrome plated to standard EN12540
- tips black finish
- heavy duty double - component handles
- jet stamp UNIOR
- for disconnecting fuel pipes

Advantages:

- spring for reopening

How to use the tool:

- This tool is used for the removal of the quick couplers that connect fuel lines. The tool has two hardened pins in the jaws that compress the couplers during removal or repair (the hose can then be removed). The jaw is dimensioned and adjusted to enable safe and easy work with great force in a limited space.

Use for:

- Opel/Vauxhall, Fiat, GM, VW, Renault etc.

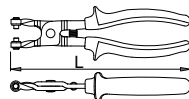

	L		
619252	206	264	4B

2080/2BI



CLIC® COLLAR PLIERS

- material: special tool steel
- surface finish: chrome plated to standard EN12540
- heavy duty double - component handles
- jet stamp UNIOR

Advantages:

- separating and closing with 180° invert of the pliers

Usage:

- to remove and reassemble CLIC spring-clips
- Pliers for are used for opening the tube clamps, enabling quick and safe removal of tubes from tube prolongations. They are also used for closing the tube clamps when tubes are attached to tube prolongations to prevent tubes from falling off the prolongations and thus ensuring safe movement of fluids. The pliers have been designed in such a way so that only a minimum force is sufficient to create large pressure upon the clamp, ensuring safe and durable connection of the tube to the tube prolongation. The pliers have been shaped in such a way so that they can be efficiently used at places which are difficult to access, thus enabling quick and easy handling. Firm and safe grip is ensured by the ergonomic shape of the handles.

Use for:

- Audi, Citroen, Fiat, Mercedes, Opel/Vauxhall, Peugeot, Renault, VW

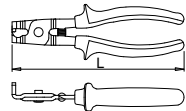

619253

L

190



244



4B



GRIP HOSE CLAMP PLIERS FOR STOPPING THE FLOW OF FLUIDS

- material: jaws – special carbon steel.
- handles made from sheet metal
- used for the stopping of the flow of oil, gasoline...

Advantages:

- jaws are free of sharp edges, so that sensitive hoses do not sustain damage.
- plastic moulded T handle enables improved grip for the user.
- fast and simple stoppage of the flow of fuel and other liquids.
- universal locking mechanism.

How to use the tool:

- The tool for stopping the flow of fluids is an indispensable tool when changing various automotive parts connected with liquid-bearing hoses. The tool's main function is the stoppage of the flow of various fluids in soft hoses so that a mechanic can replace a certain car part without interruptions or worrying over a potential spillage. The tool can be used on soft hoses in cars, trucks, farming machines as well as various nautical vessels, however, the hose diameter may not exceed 55 mm at any time, as in that case the stoppage of the flow is not guaranteed.

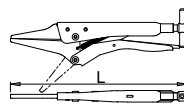
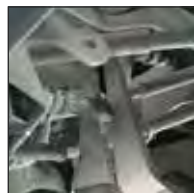
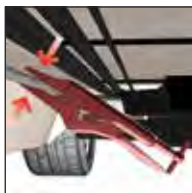

	L			
619254	285	55	611	



2082/3



GRIP PLIERS FOR CUTTING EXHAUST PIPES

- material: jaws – special carbon steel.
- handles made from sheet metal
- Cutting capacity: 25–85 mm.
- used for cutting exhaust pipes in partial replacements of exhaust systems.

Advantages:

- the plastic-coated T-handle provides better grip for the user.
- universal locking mechanism.
- very long cutting chain.

How to use the tool:

- This tool is primarily intended for cutting exhaust pipes but, due to the design of its cutting chain and blades, it can also be used for copper pipe, plastic pipe and various other pipes with diameters between 25 and 85 mm. The tool is safe and easy to use due to accessories such as: – a longer cutting chain enabling you to cut pipes with diameters of up to 85 mm; – larger cutting blades, enabling you to cut steel tube up to 3 mm thick, brass tube up to 4 mm thick, PVC tube up to 5 mm thick; – a plastic-coated T-handle that decreases the amount of force necessary to use the tool, enhances grip and prevents slipping; – a universal locking mechanism that keeps the tool in position until you release the locking mechanism and stop cutting. The cutting chain is subject to wear, which is why we are offering it as a spare part (art. 2082.1).

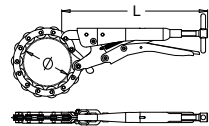

	L	ØI	ØT		
619255	330	25	85	765	IG



2082.1

SPARE CHAIN FOR ITEM 2082/3

- material cutters: alloy steel

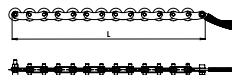
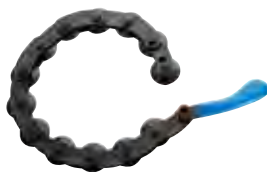

	L		
619256	305	184	1E

2083

**TELESCOPIC MAGNETIC PICK-UP TOOL WITH LIGHT**

- for lifting nuts, bolts, screws

Advantages:

- batteries protected against humidity
- included in the set: 3 LR41 batteries
- with light, for dark places between the machine parts

How to use the tool:

- This tool is intended for picking up small metal objects. It has a special light that activates automatically upon being extended from its housing. It is useful for partly unlit spaces such as the inside of engines. When no longer needed, simply fold back the tool and the light will immediately deactivate. The tool has a fastener.

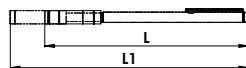

	L	L1		
619741	170	660	0.5	55
				1F



PROFESSIONAL AUTO INSPECTION SET

- with long life LED light
- available in durable plastic bag
- the magnet's lifting capacity: 3.5 kg
- included in the set: 1 round mirror O60, 1 angular mirror (65 x 42 mm), 2 bits attachments, 3 L1154F batteries, 1 bag with the SOS tool tray
- In addition to the LED light, this set includes additional mirrors to facilitate viewing of difficult-to-reach areas inside the car, making this a very useful set. The tools are also intended for lifting small metal objects such as screws, nuts, etc. The set comes in an attractive and durable bag. Individual tools have been placed in the SOS tool tray to make them easier to find.

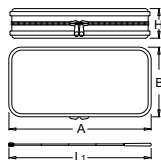

Barcode	A	B	H	L1	Magnet Capacity	Weight	Material
619742	240	110	45	650	3.5	360	PE

2085



CLAW PICK-UP TOOL

Advantages:

- This adjustable tool is easy to navigate through difficult-to-reach areas. To enable quick and reliable gripping of objects, it has three claws that extend or return to their original position upon pressing or releasing the button, respectively.

How to use the tool:

- for lifting small specially non-metallic parts like bolts, nuts, screws

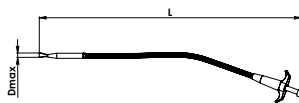

Barcode	L	D \bar{f}	Icon	Icon	Icon
619883	510	15			4A

2086



MAGNETIC TRAY

- Material: stainless steel, corrosion resistant
- keeps parts and tools right where you need them
- holds any small nuts, bolts and steel parts

Advantages:

- powerful permanent magnet cover with protective rubber foot
- can be used in any position

How to use the tool:

- With its powerful rubber-protected magnet, this magnetic tray is suitable for practically all industrial applications ranging from car repair shops to everywhere where it can be attached to a metal surface. It can be used in all positions - the magnet is so powerful that the tray can even be fitted upside-down. The tray is intended for protecting screws, nuts and the like against being misplaced, and for storing them in a central location to minimise the time needed to find a specific item.
- for usage in garage, engine, household work

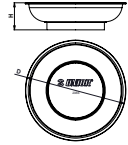

	D	H			
619728	150	40	3	387	1F

2087



FLEXIBLE PICK UP TOOL WITH MAGNET

- The flexible magnetic pickup is designed to collect metal objects from hard to reach spots.

Advantages:

- It features a flexible stem with a strongly magnetic tip.
- The magnet is capable of lifting metal objects of up to 1 kg.
- The tool is fitted with an ergonomically designed handle, ensuring easy and efficient operation.

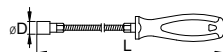

Barcode	Icon	L	D	Weight	Material
619929	1	500	15	127	4B

2089/2BI

AUTOMATIC SPRING CLIP PLIERS

- material: special tool steel
- material pivoting tip: special carbon tool steel
- surface finish: chrome plated to standard EN12540
- heavy duty double - component handles
- for hose clips on cooling, heating, fuel or screen-washer systems

Advantages:

- fits most standard size clamps
- position lock makes it easy to replace hose clamps

How to use the tool:

- The pliers are used for opening tube spring clips used on cooling and heating systems which enables quick and safe removal of tubes from tube extensions. Suitable for spring clips with a grip ranging from 18 to 54 mm. The 600 mm long Bowden cable enables efficient use in hard to reach places where clips cannot be reached with other pliers. The pliers include a toothed blocker with 8 positions for opening clips or fastening them in a custom position which makes the removal of clips easier and with no additional force necessary. The handles are designed so that when the pliers' jaws are open the widest they are easy to squeeze with as little force as possible.

Use for:

- Alfa Romeo, Audi, Citroen, Fiat, Ford, Hyundai, Lancia, MAN, Mercedes, Opel/Vauxhall, Peugeot, Porsche, Renault, Seat, Toyota, VW, Volvo, etc.

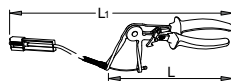

	L	L1		
620234	230	600	415	TG

2091



LED LIGHT

Advantages:

- with 26 LED lamps (21 in front and 5 on top)
- 21 LED can be switch on between 4 and 5 hours, 5 LED on top 13 hours
- with two adjustable hangers
- with three magnets
- simple light angle adjustment from 0 to 180°
- made from user friendly plastic material
- with two adapters (12/24 V in 100-240 V)
- magnet in bottom carries complete weight of LED light
- Li-Ion battery

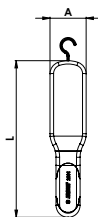
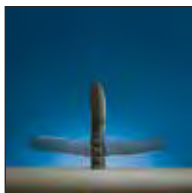
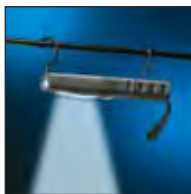

	L	A		
620237	250	55	512	1G

205/2

STRAP WRENCH

- material: chrome vanadium
- strap from rubberized cloth
- drop forged, entirely hardened and tempered
- surface finish: chrome plated according to EN12540

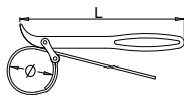

	L	\varnothing	\varnothing		
601024	220	60	140	225	1E

205.1

STRAP FOR 205/2

- strap from rubberized cloth



		
602841	62	1E



OPTICAL TESTER IN PLASTIC BOX

- for measuring the concentration of electrolytes in the battery in the range from 1,10 to 1,40 Kg/L
- for measuring the usefulness of coolant (ethylene or propylene) in the range till $-50\text{ }^{\circ}\text{C}$
- for measuring the usefulness of windscreen fluid in the range till $-40\text{ }^{\circ}\text{C}$
- scale grating 0,01 Kg/L in measuring the electrolyte concentration and $5\text{ }^{\circ}\text{C}$ in the measurement of the other two fluids
- packed in a plastic box and SOS tool tray, which allows safe storage of tester
- supplied with pipette and screwdriver to adjust the calibration
- included instructions for use

Important!

- before and after the use the tester needs to be cleaned

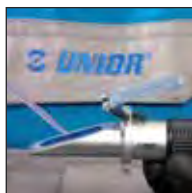

621403



315



TG

1945

MULTI-FUNCTION SCRAPER WITH BLADE GUARD

- plastic material
- blade from high alloy steel
- with blade guard
- This tool is designed for scraping off dirt stuck to various surfaces. Due to its large working surface, the tool scrapes uniformly across the entire surface. It is suitable for removing silicon putty from motor heads, baked-on seals, vignette, etc.

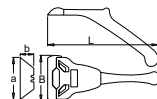

Barcode	L	B	a x b	Weight	Material
620240	165	70	60.8 x 18.9	37	1E

1945.1

SET OF 5 BLADES FOR 1945

Barcode	Weight	Material
621042	33	1E

1946

FILE HOLDER

- delivered without file, which is available as spare part (article 1946.1)

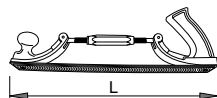

	L		
621477	350	770	1F



2030/2BI

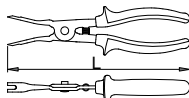
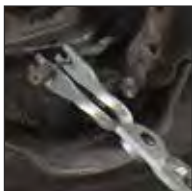

HANDBRAKE WIRE PLIERS

- material: special tool steel
- for changing hand brake cable
- heavy duty double - component handles
- jet stamp UNIOR
- Used to attach or detach the brake drum wire cable. Simply use the handbrake wire pliers to quickly tension, attach or detach the brake drum wire cable.



	L		
619734	234	256	4B

253/2DP

HOOK WRENCH WITH PIN

- material: chrome vanadium
- pins: black finish
- entirely hardened and tempered
- surface finish: chrome plated according to EN12540
- double plastic dipped handles
- The 2.3 and 2.8 mm pins are interchangeable, the distance between them is adjustable. The biggest difference between the pins is 50 mm open and 10 mm closed.

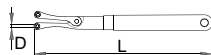

616294



123



4B



2035



BRUSH FOR CLEANING DISK BRAKE SHOES

- for cleaning brake disc shoes prior to installing new brake linings and other metal engine parts
- extremely narrow design for those hard-to-reach spaces
- Braking causes wear on the brake pads and brake lining material to accumulate in the brake disc shoe - this has to be cleaned when replacing brake pads. The narrow design of this tool allows it to be used to clean brake disc shoes and anything else that might require such cleaning.



619739



73



1E





SLIPPER TORQUE WRENCH

- reversible ratchet head
- Torque application: oneway, but always apply in direction specified on torque wrench handle
- ratchet operates in clockwise and anti-clockwise directions
- for tightening on left and right hand threads
- unmistakable signal when set torque is reached
- Default value for the recalibration interval is 12 month of use, or approximately 5.000 cycles!
- made according to standard ISO 6789
- dual scaled, Nm and Kgm

Important!

- Do not use torque wrench for untightening!
- Torque tightens only in the direction showed on the key sticker! Sticker shows the proper direction of tightening!
- The default calibration interval of the torque wrench is 12 months or 5.000 measurements from the date of end user purchase.
- ALWAYS set the measuring mechanism to starting point, at the end of work.
- When the requested torque are reached, please do not tight any more.
- Torque wrench can be damaged, if manual instructions are not considered.

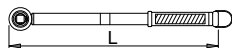
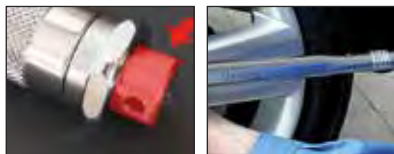

Barcode	Size	Scale	L	Weight	Price
615485	1/4"	2 - 24	270	686	1S
615486	3/8"	5 - 110	360	1100	1S
615487	1/2"	28 - 210	465	1680	1S
615488	1/2"	35 - 350	640	2930	1S
615489	3/4"	70 - 560	840	5600	1S
615490	3/4"	140 - 700	1070	8200	1S
615491	1"	140 - 980	1220	8800	1S



2201/2BI

VALVE SEAL REMOVAL PLIERS

- material: special tool steel
- surface finish: chrome plated to standard EN12540
- extra long nose
- extra slim form allows removal of valve-stem oil-seals in deep engine block places
- for valve stem sealing rings
- jet stamp UNIOR
- heavy duty double - component handles
- Valve seal removal pliers - Narrow design allows access to valve stem seals even in the tight confines of 4 valve per cylinder heads. Features serrated tips for a positive grip on the seal, heat-treated steel construction and cushioned handles.

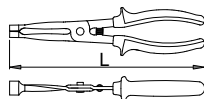

	L		
619721	275	287	4B

2213/2BI

ANGLE GAUGE

- this is used for screws on the heads of motors where car manufacturers prescribe that, as well as fastening the screws to the prescribed torque, fastening at a certain angle is also required
- if your space is limited, you can also use an extension to obtain the required height
- the scale is 360°, divided into 2° angles

How to use the tool:

- hold the angle scale by its small handle to avoid rotation during screw joining, set the indicator to zero and then fasten the screw at the prescribed angle with another tool from the 1/2" product range (e.g. a hinge handle which is longer, because the forces are considerable)

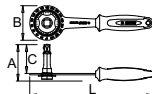

Barcode	L	B	A	C	Weight	Category
622815	270	75	80	63	428	4B



1940/2Bl



TRIM PIN REMOVER

- material: special tool steel
- ergonomic heavy duty double component handle
- for removing trim pin till 8 mm
- This tool is used for extracting fastening pins, removing trim and on various upholstery.

Advantages:

- tip angled ground
- It's ergonomic design allows easy and safe working in various positions and in difficult to reach places without damage to the items being extracted or removed.

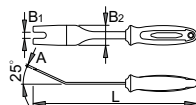

Barcode	L	B1	B2	A	Weight	Material
619267	230	8.5	28	2.5	130	4B

1940.1/2Bl



TRIM PIN REMOVER

- material: special tool steel
- ergonomic heavy duty double component handle
- for removing trim pin from 2 mm till 15 mm
- This tool is used for extracting fastening pins, removing trim and on various upholstery.

Advantages:

- tip angled ground
- It's ergonomic design allows easy and safe working in various positions and in difficult to reach places without damage to the items being extracted or removed.

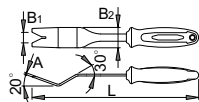

Barcode	L	B1	B2	A	Weight	Material
619268	230	16.3	28	2.5	135	4B



1940.2/2Bl



TRIM PIN REMOVER

- material: special tool steel
- ergonomic heavy duty double component handle
- for removing trim pin till 4,5 mm
- This tool is used for extracting fastening pins, removing trim and on various upholstery.

Advantages:

- tip angled ground
- It's ergonomic design allows easy and safe working in various positions and in difficult to reach places without damage to the items being extracted or removed.

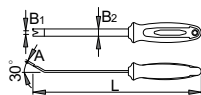

	L	B1	B2	A		
619269	230	5	10	2.5	109	4B



186.4/2A	Spark plug socket 3/8"	622513	48
192/2HX	Hexagonal screwdriver socket 1/2"	600978	71
192/2HX	Hexagonal screwdriver socket 1/2"	603420	71
192/2HX	Hexagonal screwdriver socket 1/2"	603421	71
192/2HX	Hexagonal screwdriver socket 1/2"	603422	71
192/2HX	Hexagonal screwdriver socket 1/2"	603423	71
192/2HX	Hexagonal screwdriver socket 1/2"	605923	71
192/2HX	Hexagonal screwdriver socket 1/2"	603424	71
192/2HX	Hexagonal screwdriver socket 1/2"	603425	71
192/2HX	Hexagonal screwdriver socket 1/2"	603426	71
192/2HX	Hexagonal screwdriver socket 1/2"	603427	71
192/2HX	Hexagonal screwdriver socket 1/2"	603428	71
192/2HX	Hexagonal screwdriver socket 1/2"	623141	71
192/2HX	Hexagonal screwdriver socket 1/2"	623142	71
192/2HX	Hexagonal screwdriver socket 1/2"	619894	71
192/2HX	Hexagonal screwdriver socket 1/2"	619895	71
192/2HX	Hexagonal screwdriver socket 1/2"	619896	71
192/2HX	Hexagonal screwdriver socket 1/2"	619898	71
192/2HX	Hexagonal screwdriver socket 1/2"	619899	71
192/2HX	Hexagonal screwdriver socket 1/2"	619900	71
192/2HX	Hexagonal screwdriver socket 1/2"	619901	71
192/2HX	Hexagonal screwdriver socket 1/2"	619902	71
192/2HX	Hexagonal screwdriver socket 1/2"	619904	71
205.1	Strap for 205/2	602841	87
205/2	Strap wrench	601024	87
253/2DP	Hook wrench with pin	616294	91
264	Slipper torque wrench	615485	93
264	Slipper torque wrench	615486	93
264	Slipper torque wrench	615487	93
264	Slipper torque wrench	615488	93
264	Slipper torque wrench	615489	93
264	Slipper torque wrench	615490	93
264	Slipper torque wrench	615491	93
300/5	Tyre lever	617661	37
300/5	Tyre lever	601755	37
300/5	Tyre lever	601756	37
300/5	Tyre lever	601757	37
300/5C	Tyre lever with handle	613103	38

300/5C	Tyre lever with handle	613104	38
300/5C	Tyre lever with handle	613105	38
631	Car light tester 6 - 12/24 V	601688	50
631	Car light tester 6 - 12/24 V	601689	50
631B	Car light tester 6 - 12/24 V	619856	51
689.1/4	Arm for 689/2BI	623089	42
689.1/4	Arm for 689/2BI	623090	42
689.1/4	Arm for 689/2BI	623091	42
689.1/4	Arm for 689/2BI	623092	42
689.1/4	Arm for 689/2BI	623093	42
689.1/4	Arm for 689/2BI	623094	42
689/2BI	Inner bearing puller	622587	43
964MOTO1	Set of motorbike tools in SOS tool tray	624979	62
964MOTO2	Set of motorbike tools in SOS tool tray	624980	62
964MOTO3	Set of motorbike tools in SOS tool tray	624981	63
964MOTO4	Set of motorbike tools in SOS tool tray	624982	64
964MOTO5	Set of motorbike tools in SOS tool tray	624983	65
964MOTO6	Set of motorbike tools in SOS tool tray	624984	65
964MOTO7	Set of motorbike tools in SOS tool tray	624985	66
964MOTO8	Set of motorbike tools in SOS tool tray	624986	66
1940/2BI	Trim pin remover	619267	96
1940.1/2BI	Trim pin remover	619268	96
1940.2/2BI	Trim pin remover	619269	97
1945	Multi-function scraper with blade guard	620240	89
1945.1	Set of 5 blades for 1945	621042	89
1946	File holder	621477	90
1977/6	Oil-filter wrench	620949	23
1977/6	Oil-filter wrench	620950	23
1977/6	Oil-filter wrench	620951	23
1977/6	Oil-filter wrench	619258	23
1977/6	Oil-filter wrench	619259	23
1977/6	Oil-filter wrench	620267	23
1977/6	Oil-filter wrench	620268	23
1977/6	Oil-filter wrench	619260	23
1977/6	Oil-filter wrench	619261	23
1977/6	Oil-filter wrench	620269	23
1977/6	Oil-filter wrench	619262	23
1977/6	Oil-filter wrench	620952	23

1977/6	Oil-filter wrench	619263	23
1977/6	Oil-filter wrench	619264	23
1977/6	Oil-filter wrench	619265	23
1980	Optical tester in plastic box	621403	88
2026/2	Separator puller	619273	44
2026/2	Separator puller	619274	44
2026/2	Separator puller	619275	44
2026/2	Separator puller	619273	85
2026/2	Separator puller	619274	85
2026/	Separator puller	619275	85
2030/2Bl	Handbrake wire pliers	619734	90
2034/2Bl	Tool for set tyres valvelets	619738	36
2035	Brush for cleaning disk brake shoes	619739	92
2038	Inner bearing race puller	620228	45
2038	Inner bearing race puller	620228	87
2042/2	Tool for tyres valvelets	621998	37
2051/4	Suspension compressor for shock absorber springs	619279	39
2076/1	Roller-type stud extractor	619238	66
2076/1	Roller-type stud extractor	619239	72
2076/1	Roller-type stud extractor	619240	72
2076/1	Roller-type stud extractor	619241	72
2076/1	Roller-type stud extractor	619242	72
2076/1	Roller-type stud extractor	619243	72
2076/1	Roller-type stud extractor	619244	72
2076/1	Roller-type stud extractor	619245	72
2076/1	Roller-type stud extractor	619246	72
2076/1	Roller-type stud extractor	619247	72
2076/1	Roller-type stud extractor	619248	72
2076/1	Roller-type stud extractor	619249	72
2077/2Bl	Spring clip pliers	619250	74
2078/2Bl	Slotholder pliers for OETIKER® collars	619251	75
2079/2Bl	Quick coupler pliers for fuel pipes	619252	76
2080/2Bl	CLIC® collar pliers	619253	77
2081/3	Grip hose clamp pliers for stopping the flow of fluids	619254	78
2082/3	Grip Pliers for cutting exhaust pipes	619255	79
2082.1	Spare chain for item 2082/3	619256	80
2083	Telescopic magnetic pick-up tool with light	619741	80
2084	Professional auto inspection set	619742	81

2085	Claw pick-up tool	619883	82
2086	Magnetic tray	619728	83
2087	Flexible pick up tool with magnet	619929	84
2089/2BI	Automatic Spring Clip Pliers	620234	85
2091	LED light	620237	86
2151/2BI	Spark plug pliers	619732	49
2201/2BI	Valve seal removal pliers	619721	94
2202.1/2	Pressure pieces for valve spring compressor	623218	17
2202.1/2	Pressure pieces for valve spring compressor	620567	17
2202.1/2	Pressure pieces for valve spring compressor	620208	17
2202.1/2	Pressure pieces for valve spring compressor	620209	17
2202.1/2	Pressure pieces for valve spring compressor	620210	17
2202.1/2	Pressure pieces for valve spring compressor	620211	17
2213/2BI	Angle gauge	622815	95
3000/6	Front stand for motorcycle	620259	54
3000.1	Adaptor for front stand	624325	56
3001/6A	Rear stand for motorcycle with universal adaptor	620260	55
3001/6B	Rear stand for motorcycle with V adaptor	624300	55
3001.1	Universal adaptor for rear stand	624326	56
3001.2	V adaptor for rear stand	624327	57
3001.3	Base for stand 3000/6 and 3001/6	624328	57
300CCB	Set of tyre levers with handle	613106	38
3050/2BI	Clutch and gear wheel holding tools	620261	14
3051/2BI	Rotor and sprocket holding tools	620262	15
3052/2BI	Valve spring compressor for motorbikes	620263	16
3054	Flywheel puller with internal thread	620270	22
3054	Flywheel puller with internal thread	620271	22
3054	Flywheel puller with internal thread	620272	22
3054	Flywheel puller with internal thread	620273	22
3054	Flywheel puller with internal thread	620274	22
3054	Flywheel puller with internal thread	620275	22
3054	Flywheel puller with internal thread	620276	22
3054	Flywheel puller with internal thread	620277	22
3055/4A	Flywheel puller with external thread	620278	18
3055/4B	Flywheel puller with external thread	620279	19
3056/2	Socket 1/2" with thin wall	620280	20
3056/2	Socket 1/2" with thin wall	620281	20
3056/2	Socket 1/2" with thin wall	620282	20



Blank page with horizontal lines for index entries.

